

BELLATERRA HOME

Model: 9002-24

Tools List (Not included)

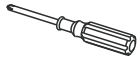

Screwdriver



Silicone

Parts List (Included)



Foam pad
(4pcs)

Put the integrated ceramic sink on the top of vanity, and check if it stays firm on the vanity.

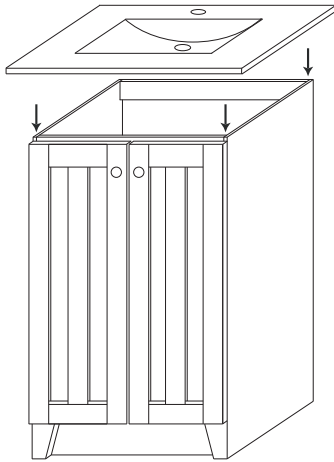

Step 1

If the ceramic sink is not staying firm on the vanity, please use the foam pad to fill the gap.

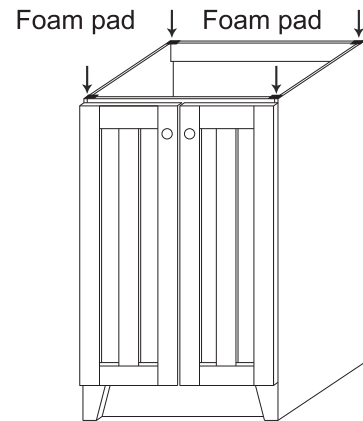

Step 2

Finally, place the ceramic sink again to check the stability.

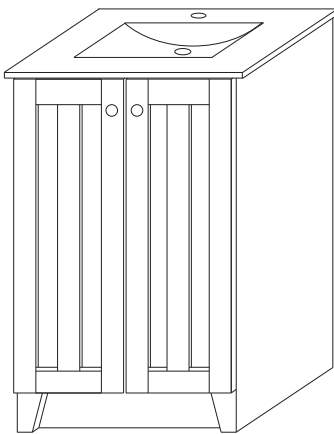

Step 3

INSTALLATION TIPS:

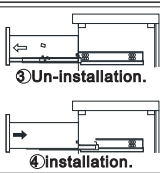
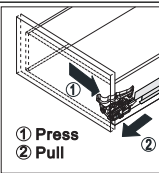
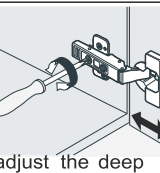
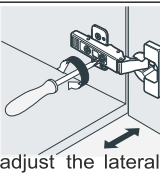
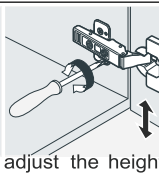
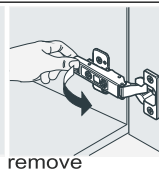
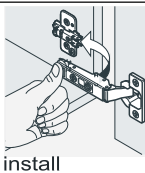

NOTE: SINK STYLE, SHAPE, FAUCET HOLES, CUTOUT ON TOP, VANITY MAY VARY FROM THE PICTURE ABOVE. INSTRUCTIONAL PURPOSE ONLY.

Professional installation is recommended.
www.bellaterra-home.com

Bellaterra Home LLC, All Rights Reserved 2016